

DOCK
P R O D U C T S

steril[®]

THE STERTIL DOCK PRODUCTS

HOW TO DESIGN A LOADING BAY



STERTIL
SUPERIOR SOLUTIONS BY
QUALITY PEOPLE

Superior solutions by quality people

The Steril Group offers its worldwide customers bespoke, technologically sophisticated solutions for their dock equipment and heavy duty lifting requirements, including the best possible service from strong local partners. These superior solutions are conceived, developed and realised by a team of specialised professionals with unique experience. Thanks to its “quality people”, its total in-house production process and its international organisation, Steril is a world leader in the field of dock levellers and dock shelters.



The loading bay is the logistical bottleneck of a company site

The loading bay makes or breaks a logistics chain. Therefore, a lot of things have to be considered when designing a safe and efficient loading bay. This guide will help you not only to solve the most tricky problems but also overcome unexpected internal and external factors that can cause problems during the transfer of goods.

Different issues and factors will be discussed and explained in various chapters. Because of the diversity of circumstances and environments in which docks are used, it is not possible to reflect on every loading situation. However, if you need particular information or would like to receive more specific details, please contact us. We will be happy to make an appointment with you to provide all the assistance you need.

logistics starts
and ends with

DOCK PRODUCTS



Index

1.	The number of loading bays	4	10.	Ancillary dock products:	40
2.	The site	6	A.	loading pit constructions	40
3.	The loading pit	8	B.	dock bumpers	42
4.	The dock platform	10	C.	dock lights	43
5.	The dock leveller	18	D.	LA/HA mini dock leveller	43
6.	The dock shelter	24	E.	wheel guides	44
7.	The overhead door	34	F.	truck restraint	44
8.	Internal transport equipment	36	G.	dock houses	45
9.	Safety standard EN 1398	38			

1.0 THE NUMBER OF LOADING BAYS

When determining the required number of loading bays, we recommend that you consider a range of factors that could influence both your current and future business plans.

Traffic scheduling

It's important to be aware of how many vehicles are likely to be loaded/unloaded at the same time. Often, the busiest times at distribution centres occur during the same morning and evening periods. Of course, a balance needs to be reached that provides enough loading bays to cope with these busy periods without having many standing unused during the rest of the day.

Processing of goods

Another factor to be considered is the way in which different goods may be handled. If processing activities, such as sorting, packing or labelling, need to be carried out within the warehouse, it will be advisable to have a sufficient number of loading bays to prevent internal handling equipment having to transport goods over long distances. It therefore makes sense to position loading bays as near as possible to the areas where on site processing takes place.

Receiving and Despatch

Many companies rely on separate loading bays for receiving and despatching goods. Frequently, these loading bays are located on different sides of a warehouse to allow the smooth processing of goods in and goods out. This scenario also needs to be considered when deciding upon the number of required loading bays.



Carefully determine the number of loading bays



2.0

THE SITE

It is important to avoid bottlenecks as trucks arrive on site to access loading bays. Properly designed road layouts that enable vehicles to travel quickly and safely with a minimum of manoeuvring will help to eliminate the problem. Efficient traffic management, including strict control over the directional flow of trucks, will also contribute greatly to safe and smooth vehicle movement. For instance, in countries where trucks are driven on the left, a clockwise system around a warehouse makes it easier for drivers whilst the opposite is true in countries where vehicles use the right hand lane. Also, this system ensures that drivers' blind spots are eliminated when reversing into position.

When designing a loading bay it is essential to take into account the different dimensions of trucks. In most European countries, a truck with a trailer length of 18 metres is permitted. If you do not have accurate information concerning your truck dimensions, you should assume that it meets maximum permitted dimensions.

The parking and manoeuvring space in front of the dock should be twice the length of the largest truck plus two metres, e.g. an 18 metres long trailer requires a space of 38 metres. Furthermore, the minimum space between the truck and the dock wall should be 1.4 metres.

The road itself can be made of concrete, asphalt, concrete plates or brick/clinker paving. Whilst concrete is an expensive option, it will not suffer damage caused by the weight of vehicles and trailers.

Also, the installation of wheel guides onto a concrete road surface is straightforward. Good results have also been achieved utilising concrete driving plates providing these are placed on a well stabilized foundation.

When constructing a loading bay, it is advisable to incorporate personnel doors to allow drivers to enter the warehouse easily and safely.

During winter, snow and ice must be removed promptly from the parking and manoeuvring areas to reduce the risk of accidents. As well as maintaining a ready supply of salt, it may be advisable to consider underground heating within the bay.

Many different systems are available and technical advances mean that this can be an effective and cost efficient solution.

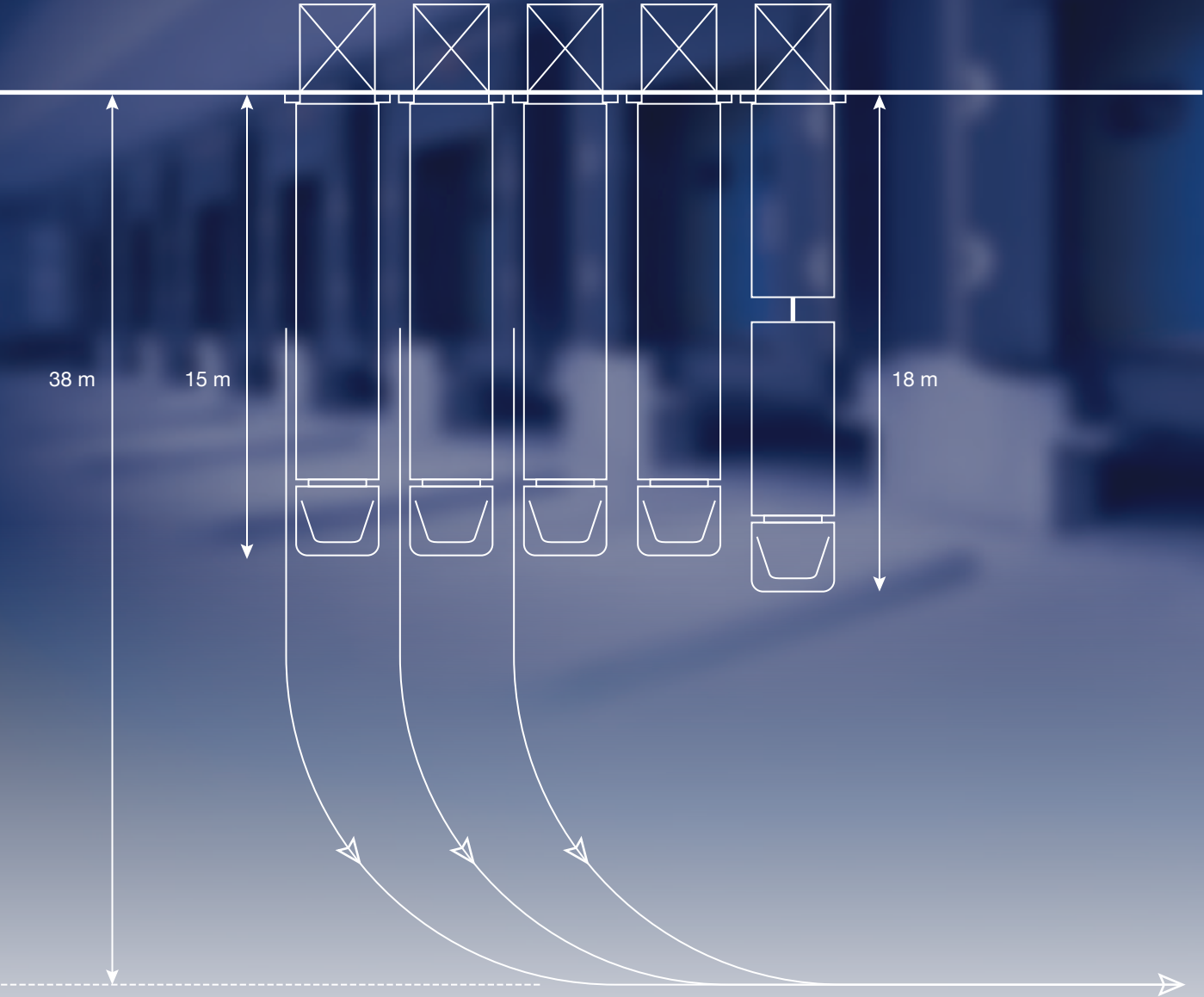

 Make sure you have enough space to dock your vehicle

3.0

THE LOADING PIT

To reduce the difference in height between the yard and the truck floor, two options are possible:

- raise the dock floor up to the level of the truck floor
- create a depressed driveway approach.

The construction of the latter may be unsuitable due to soil condition or the ground water level. Also, a steep decline can create problems because when a truck is not horizontal during loading/unloading operations, the following problems might occur:

- wheeled loads can fall out when the truck's doors are opened
- the loading/unloading process is more difficult
- internal handling equipment is under increased pressure
- rainwater can run from the roof of the truck into the building
- the dock bumpers will be overburdened
- damage to the overhead door and building.

Loading pit design

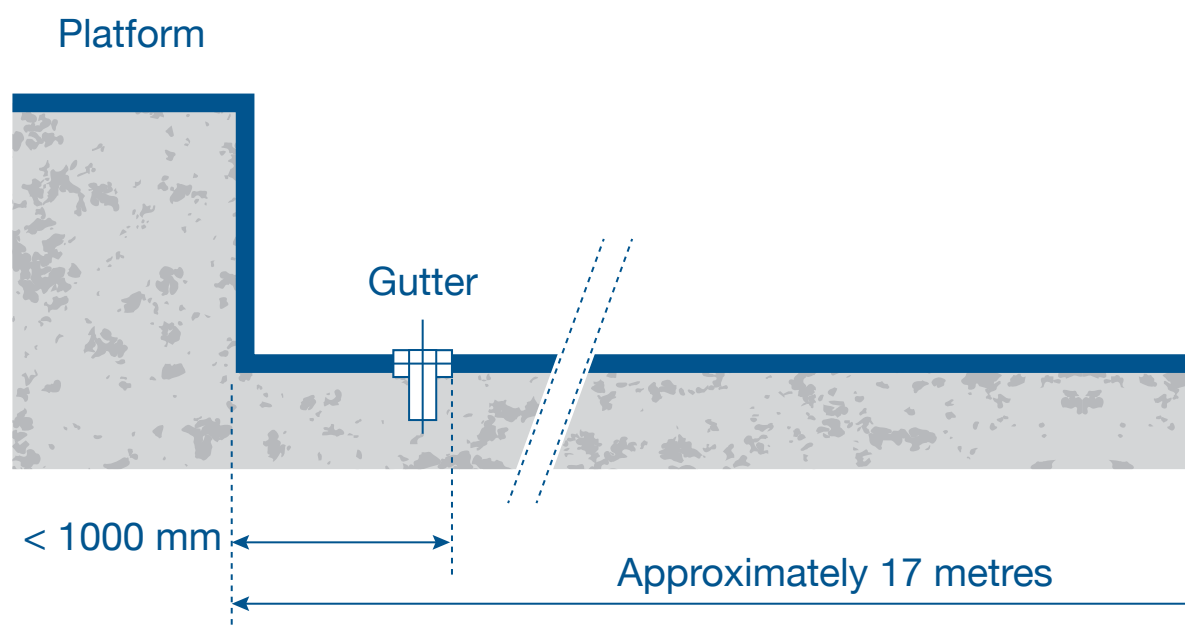

To solve the problem, depending on the yard, you can build a flat lane of 16-18 metres directly at the front of the dock before the slope begins. A drainage channel is necessary to remove rainwater. In this situation the truck is parked straight which will lead to smooth and simplified loading/ unloading. The height difference between the straight lane and the road should be bridged with a gradient percentage of a maximum of 10%. When this incline is larger than 10%, problems can arise as trucks drive in and out. In extreme circumstances, a truck cabin and trailer may even hit each other.

A good loading pit is straight and has a maximum gradient of 10%

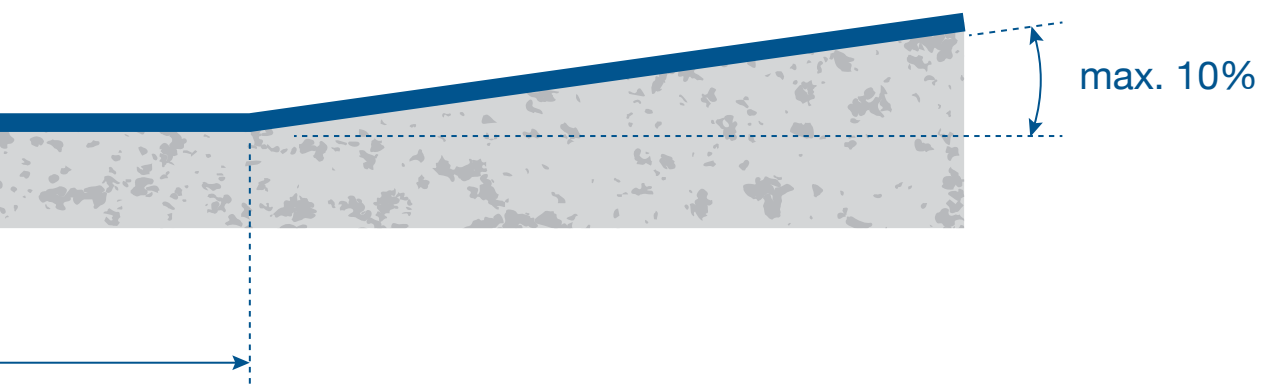

4.0

THE PLATFORM



Aim for the smallest difference between the average truck floor height and the platform

The platform

There is wide variety in models and truck dimensions, so it is likely that trucks of different heights will park at the same dock. Special trucks, such as refrigerated trucks, will be higher, even when they are built on the same frame as other trucks, due to the insulated floor. To determine the average floor height of the trucks, you should look at the lowest loaded truck and the highest unloaded truck. However, it is advisable to omit occasional vehicles with extremely low or high floor when calculating the average floor height.

To accommodate these special trucks, you may consider dedicating certain docks to ensure efficient loading and unloading. These docks could feature particular platform heights or longer dock levellers (also look at chapter DOCK LEVELLER).

Of course, it is essential to minimize the gap between the average truck floor and platform height. The chart below shows how big the differences can be with various types of trucks.

Truck floor heights in mm, 450 - 650 - 800 - 900 - 1.000 - 1.100 - 1.200 - 1.300 - 1.400 - 1.500 - 1.600	
Volume-transport	
Delivery vans / city vehicles	
Trailers / refrigerated trucks	
Containers	

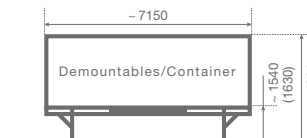
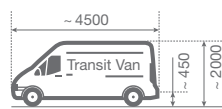
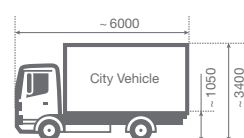
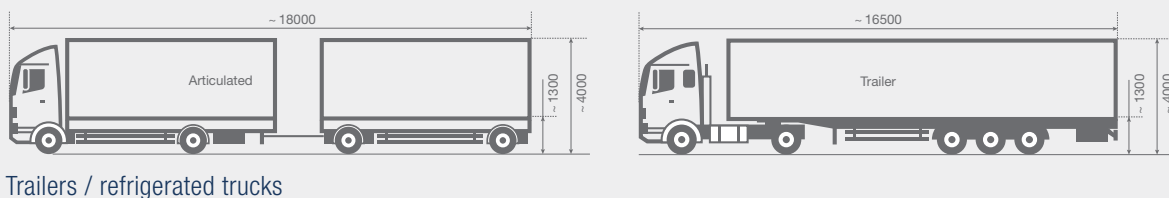
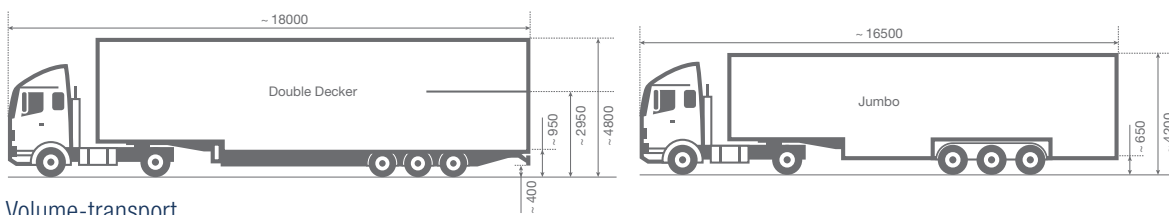

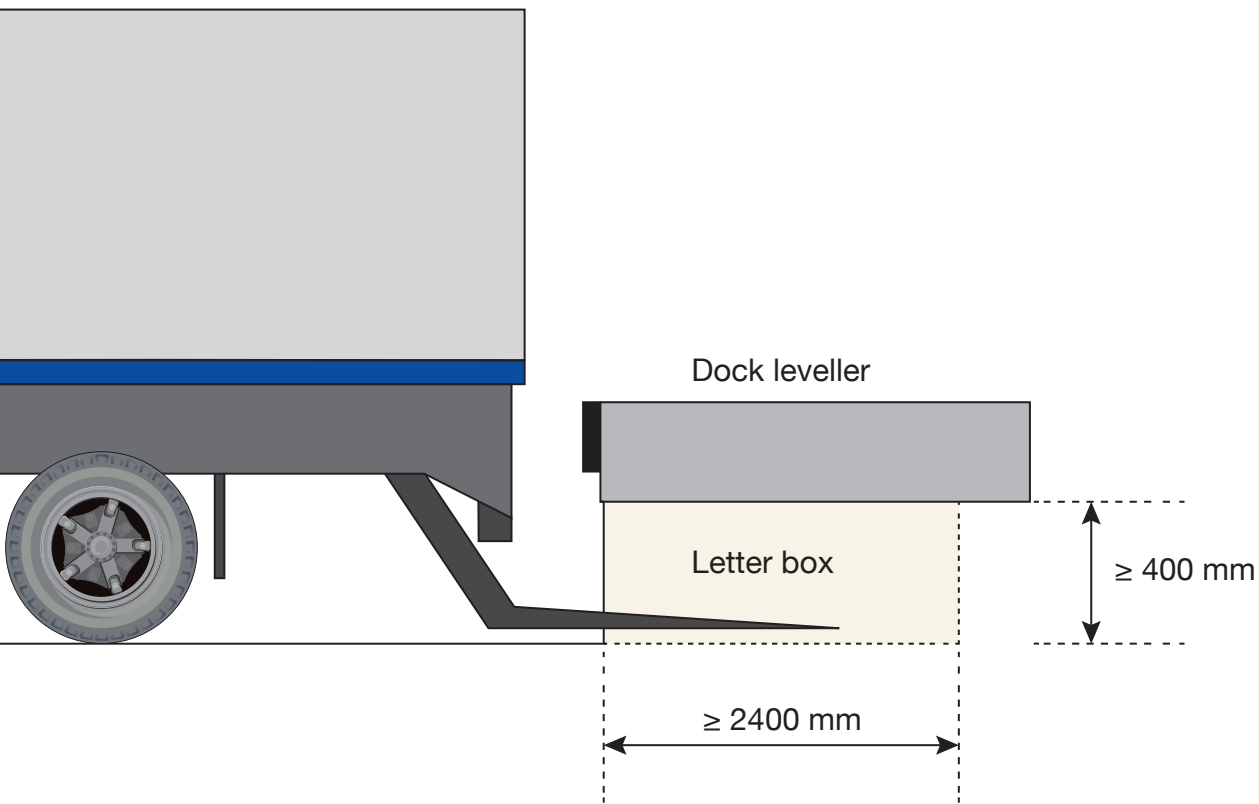

It is not always possible to make an exact estimate of the kinds of trucks that will dock. However, the most common platform height is 1250 mm which is suitable for an average warehouse or trailer park.

Trucks with hydraulic tailboards need a space under the dock leveller, known as a letter box. The tailboard slides under the dock leveller into the letter box to allow unrestricted use of the leveller. Letter box slots can be protected by a PVC seal that prevents dirt and debris blowing into the opening.

This PVC seal bends away as soon as the truck reverses.

The letter box should be 3000 mm wide and have sufficient depth to accommodate the length of the tailboards. However, we recommend a minimum depth of 2400 mm and a minimum height of 400 mm (also depending on the build-in height of the leveller and chosen platform height). These dimensions will ensure that the letter box is easily accessible.

The distance between parked trucks should be big enough to open and close the drivers' doors. Too small a gap can cause problems with parking and driving out. Standard bay centres should be at least 3700 mm although, when accommodating wide trucks with open doors, this should be increased to approximately 4000 mm (except for refrigerated and freezer trailers - please see footnote). The recommended distance between the truck and the loading pit edge is 1500 mm.

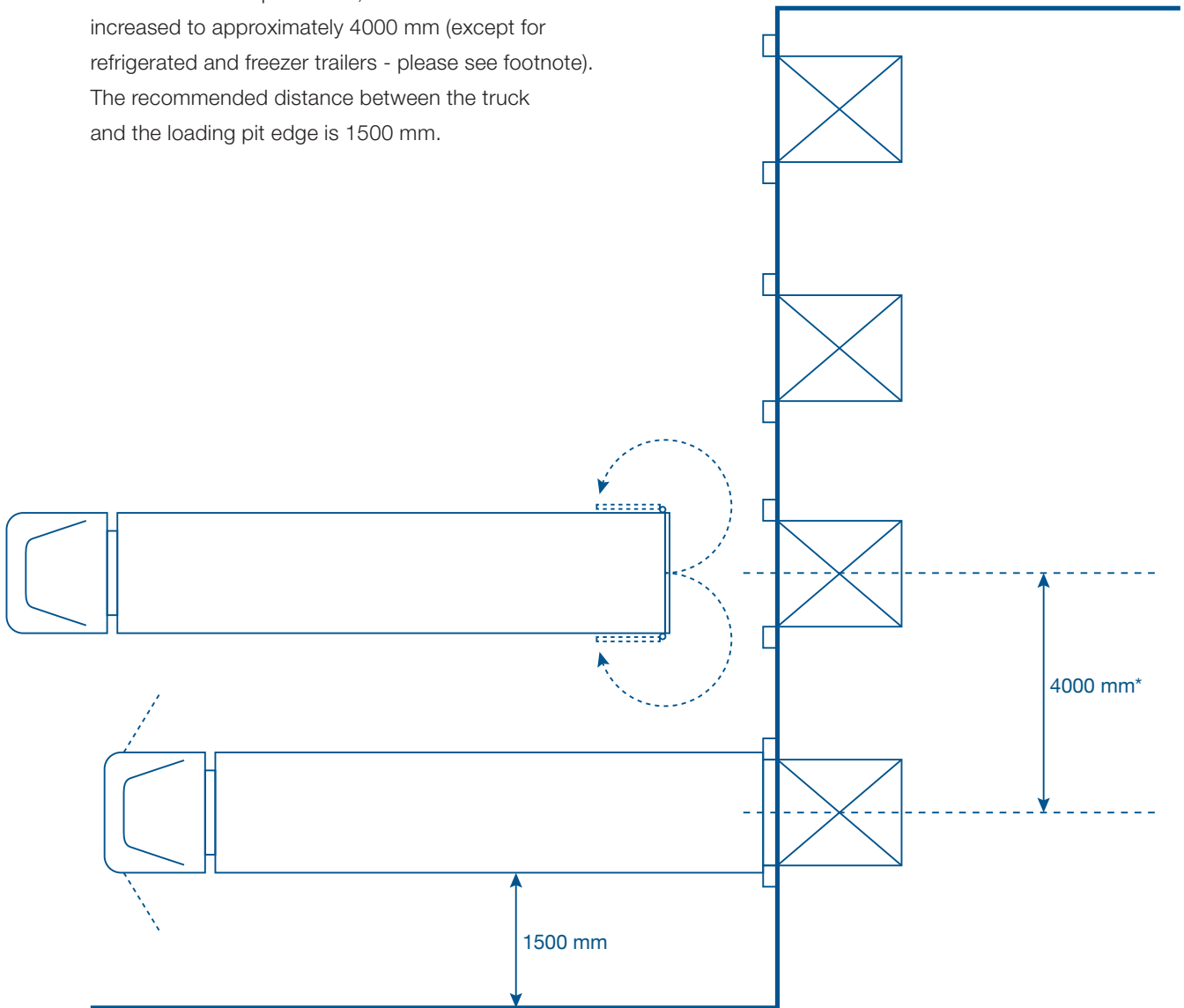

* Most refrigerated & freezer trailers require a distance of 4200 - 4400 mm

4.1 The enclosed dock

Here the trailer is parked inside the building or sheltered area during loading and unloading but the construction costs are high and there is limited

space. Also, a ventilation system is required. However, it provides good protection for goods and personnel.

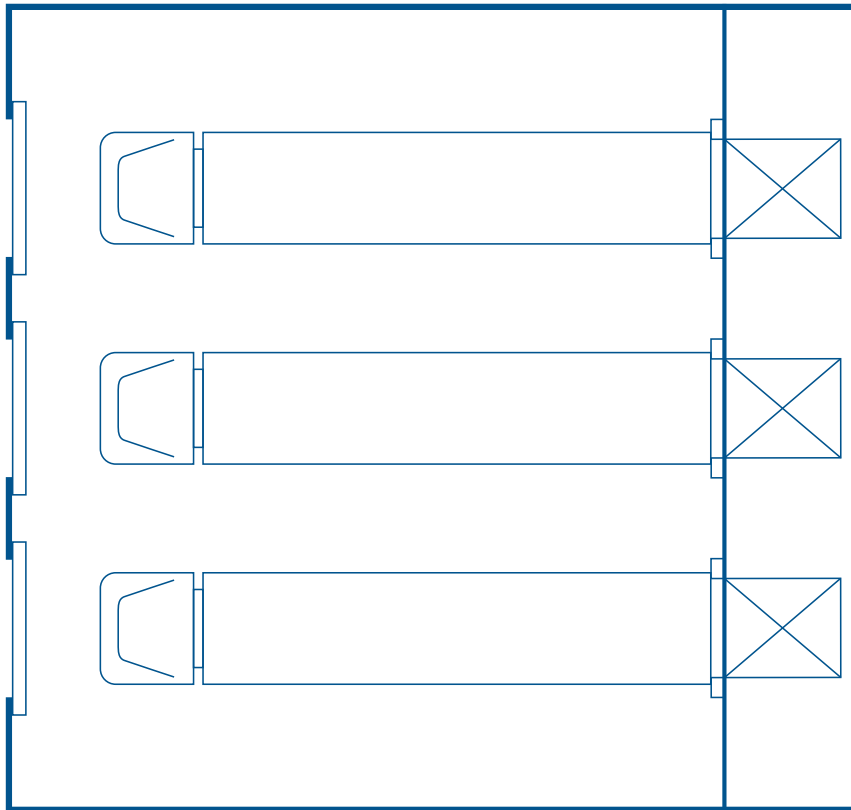

4.2 The flush dock

In this situation, the truck backs up against the building wall. The use of a dock shelter creates a seal between truck and building. This is the most common installation and the overhead door closes

down onto the front of the dock leveller. In special cases, e.g. in a temperature controlled space, the seal may require extra attention.

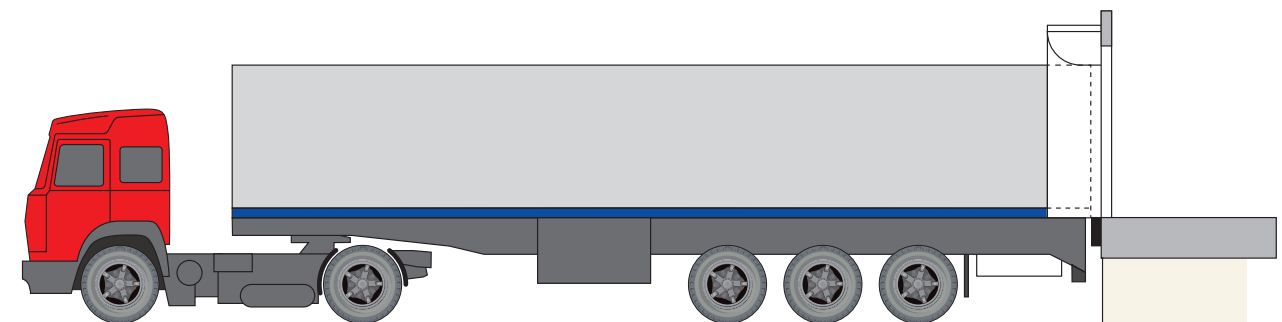

A line up with extra insulation can be applied in two different ways:

A. A door in front of the dock leveller

The door is installed in a tailor-made space and the leveller is positioned further back to allow the door to shut along the front side. If free access is required to the letter box, the door may be shut on an intermediate floor. Since this would create a greater distance between leveller and truck, the leveller must incorporate a telescopic lip. This continuously variable, extendable lip can bridge the building, door and concrete construction without problems.





B. The dock leveller outside the building

By using a dock house, the dock leveller is located in front of the insulated building thereby ensuring that high insulation values remain intact. The dock house construction may incorporate concrete and/or a steel framework.



4.3 A saw tooth dock

In situations where manoeuvring space is limited, a saw tooth arrangement may be the best solution. The manoeuvring space will be increased relative to the angle of the building. Approach roads need to be designed in such a way that trucks can leave in the direction of the angle of the dock.

The trucks need less manoeuvring space because they are already lined up in the 'drive away' direction. However, extra building space is required for this saw tooth layout and useable space between the levellers is limited.

A black and white photograph of the Tower Bridge in London, showing its two towers and suspension cables. The bridge's two bascules (dock levers) are raised, revealing the interior structure. The sky is filled with dramatic, dark clouds. In the foreground, there are large, semi-transparent grey circular shapes and a small red arrow pointing upwards.

5.0

THE DOCK
LEVELLER



The dock leveller

The length of the leveller is closely connected to the height difference between truck floor and platform. Also, the maximum gradients should be taken into account when making calculations. They can be a determining factor as to what kind of internal transport equipment you may need. (More information is provided in chapter 8.) The width of the leveller depends on the internal width of the loading space of the vehicle, as well as the accuracy of the driver as he aligns his truck with the dock.



The main consideration when operating a dock leveller is not the highest or lowest position, but the actual working range. The working range of an average leveller is about 300 mm above and below platform height. When you have a platform height of 1250 mm, vehicles with a floor height of 950 to 1550 mm can load and unload. When, for example, a 2000 mm long leveller has a working range gradient of 300 mm above platform level, or exceeds your internal transport equipment, you will need a longer leveller. The maximum legal gradient is 13%. (More information is provided in chapter 8.)



Standard, multiple leveller widths are available between 1830 and 2250 mm. We recommend that you choose the largest width possible because it simplifies the placing of loads. Do not, however, choose the width of the leveller too close to the internal vehicle width because, frequently, a truck is not parked perfectly straight. A margin of at least 150 mm on both sides of the leveller is recommended. Wheel guides make it easier to park straight and the required margin can be made smaller.

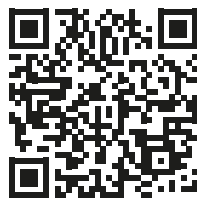

[Read more in our
Leveller brochure](#)

Example:

The minimum internal vehicle width is 2400 mm
Subtract a manoeuvring deviation of 150 + 150 mm
This leaves a maximum leveller width of 2100 mm

STERTIL
SUPERIOR SOLUTIONS BY
QUALITY PEOPLE

Choosing the correct type of dock leveller is just as important as determining the right dimensions. Stertil dock levellers include both manually and electro-hydraulically operated models. Except for the electro-hydraulic telescopic lip operated leveller, all models feature a special open lip hinge. Because of the shape and place of the hinge plates, the top plate and beams have a weight absorbing construction. When the lip is vertical, dirt automatically falls through the openings, so a self-cleaning hinge is obtained. This is a big plus because, when dirt piles up, it can affect the smooth operation of the leveller. The Stertil patented open lip hinge has a lifetime guarantee.

To ensure stability when heavily laden fork lifts drive over a leveller in resting position, two legs support the front edge to prevent the leveller from sinking. When the lip extends, these legs automatically retract. Cross traffic is perfectly safe. The rear hinge is specially constructed to allow the platform to twist 125 mm on both sides. This means that an uneven truck floor will not cause a dangerous gap between lip and floor.

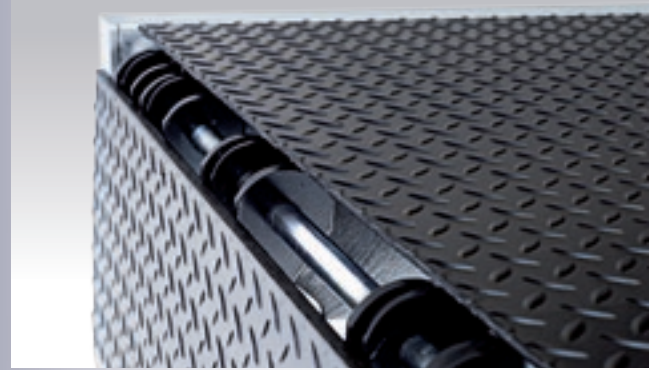

Unique open lip hinge

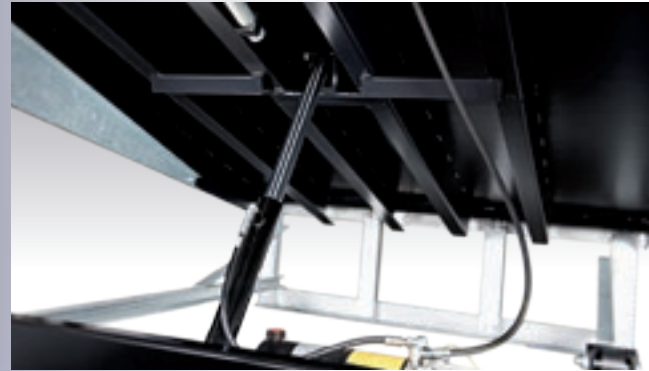

One hydraulic main cylinder



The platform can twist 125 mm on both sides



Two safety supports

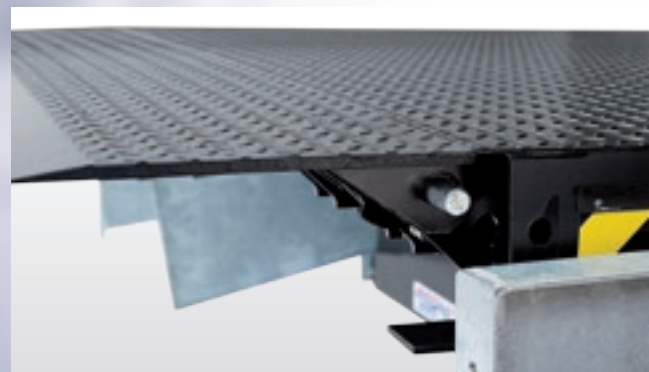

The lip angle is standard 7.5°

5.1 The Hydraulic swing lip leveller

Simple operation of the S / P Series leveller is achieved by pressing a button on the operating panel. The platform rises and, in the highest position, the lip hinges on its own. By operating the panel again, the platform returns to its original position. There is a cylinder on the front angle to support the platform completely in an 'emergency stop' situation. The hydraulic pump unit is mounted at the front and can be reached easily for maintenance and inspection. There are many sizes of hydraulic leveller, details of which you can find in our detailed brochure.



5.2 The Hydraulic leveller with telescopic lip

The S- P-Series levellers referred to previously all have a hinged lip. The X-Series dock leveller with telescopic lip, however, is operated using three buttons:

- platform up
- lip goes out
- lip goes in

The telescopic lip is continuously variable, making it perfect for all loading and unloading operations. This model is also suitable for an insulated environment where the dock leveller is positioned behind an overhead door (chapter 4.2a). During the transfer of goods, both the lip and platform will follow the movements of the truck. After loading/unloading, the leveller can be simply returned to its resting position. This leveller is available in more than 30 different sizes and full details are shown in our brochure.



We have the perfect dock leveller
for every application

5.3 The Advantage of the Stertil Leveller with One Hydraulic Cylinder

- High quality reliable high pressure hydraulic cylinder.
- Ideal position under the platform to transfer all load forces from the platform to the frame and pit construction.
- Maximum safety in an 'emergency stop' situation requiring just one cylinder to close. The combination of the middle position and high pressure ensures that the cylinder is capable of resisting the high impact from the falling platform and the load.



5.4 Solutions for the food/meat industry

In food chain logistics, the highest standards are demanded in the loading and unloading of vehicles. To avoid sensitive loads being exposed to external influences such as temperature, dust, insects and birds, the aim is to create the optimum seal between trailer and building. This is possible with a 'cool chain' dock, which works as follows:

- The dock leveller is specifically designed for this situation and is just under ramp level in resting position between two recesses in the front section of the warehouse floor. The sectional door closes in front of the leveller to exclude all thermal bridges.
- The trailer docks with closed trailer doors. Picture [1].
- The inflatable dock shelter is activated and seals the trailer as tightly as possible. Picture [2].
- The sectional door of the warehouse can now be opened. Picture [3].
- Then the lip can be extended, covering the gap between the building and the back of the trailer. Picture [4].
The trailer doors can be opened safely and can be parked in the recesses provided on the ramp next to the leveller. Picture [5].
- With the leveller now released and the lip positioned on the lorry floor, loading and unloading can commence after the traffic light has turned green. Picture [6].
- As soon as loading or unloading has finished, the above procedure is followed in reverse order. Utilising specially-designed control software, this procedure can take place almost fully automatically.

FOOD/MEAT INDUSTRY

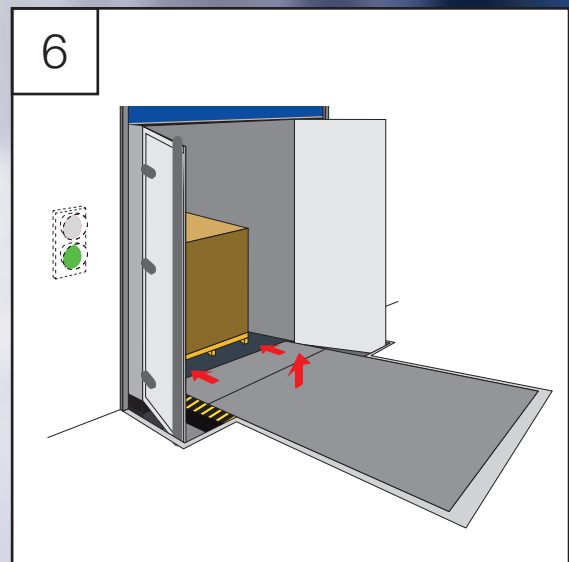
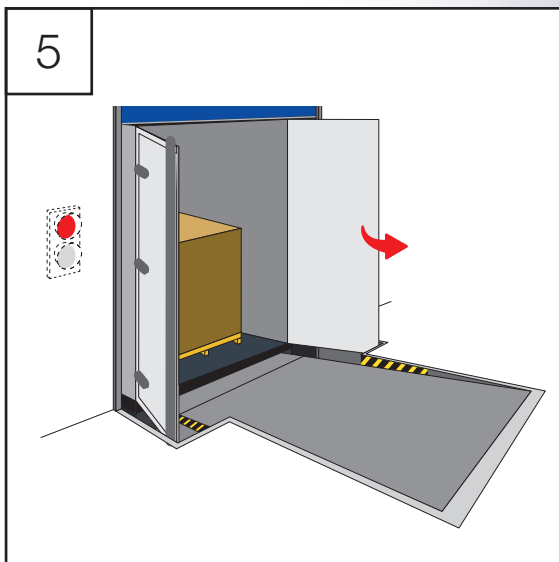
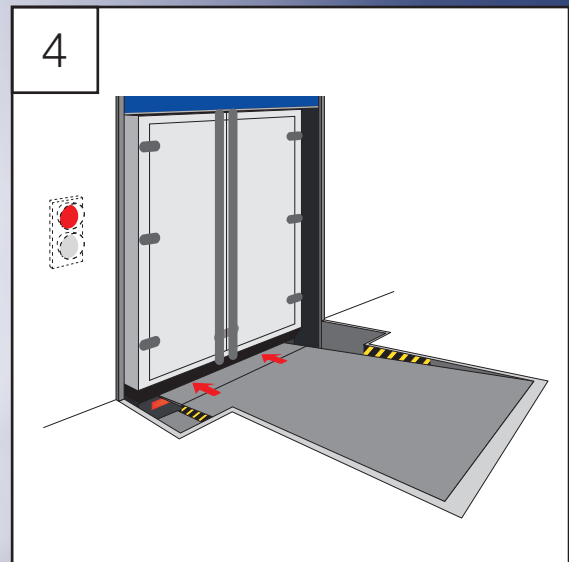
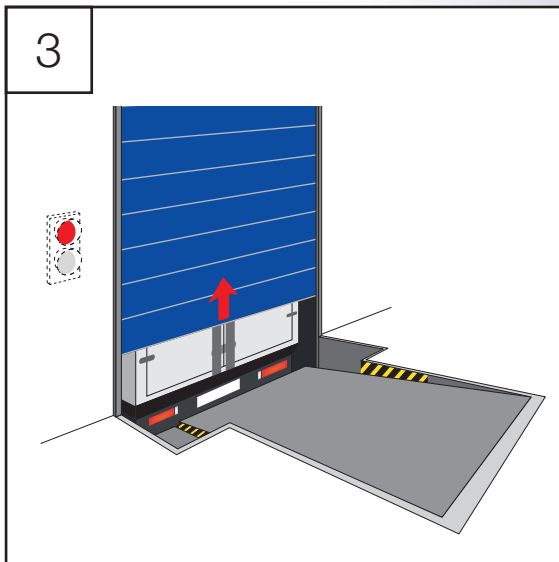
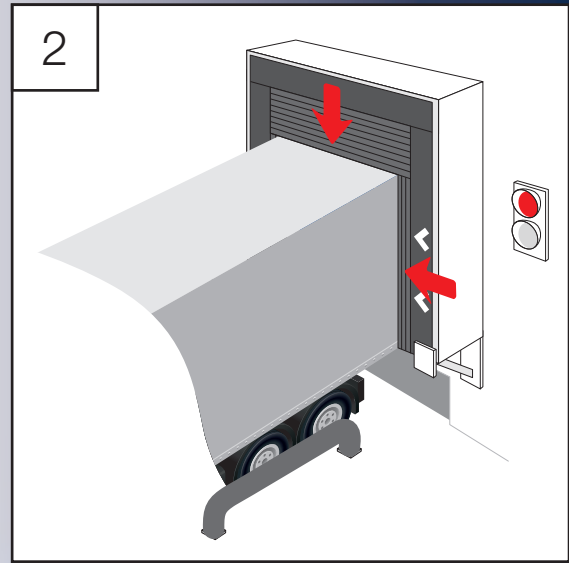
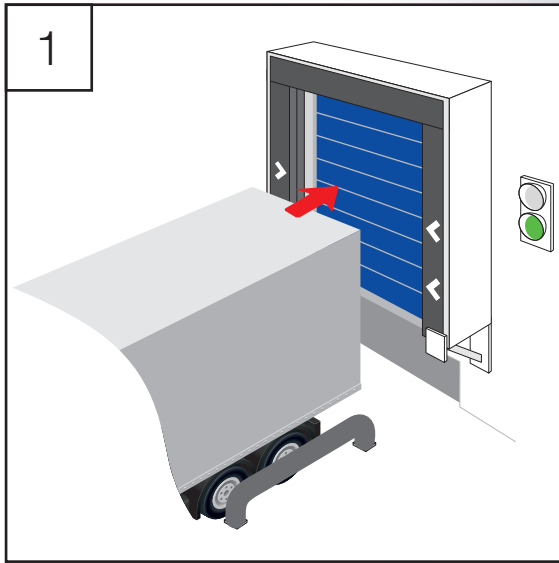

6.0

THE DOCK SHELTER



The dock shelter

Loading bays are exposed to all weathers. The use of shelters keeps adverse weather conditions outside by closing the gap between the truck and the building, restricting loss of heat.

Dock shelters protect products by keeping out dust and insects, which is why the food sector in particular has made the use of shelters obligatory. With the gap around the loading or unloading trucks sealed, you have complete control of access to your warehouse, even with an open door.

There are three types of dock shelters, namely:

- inflatable shelters
- curtain shelters
- cushion shelters



inflatable
shelters
e.g. WI, WIS



curtain
shelters
e.g. WL, WE



cushion
shelters
e.g. TP, TI

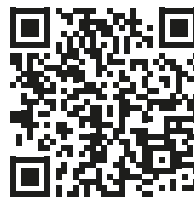

Read more in our
Shelter brochure

6.1 Inflatable shelters

Inflatable shelters incorporate air cushions positioned around the truck that are inflated by a fan. The pressure of the cushion against the sides and the roof of the truck ensures a perfect seal. The fan provides a continuous air flow thereby guaranteeing a constant pressure of the cushions against the truck. When the dock shelter is not in use, the inflatable components deflate neatly behind the front curtains in the housing made of 40 mm sandwich panels. High visibility indicators on the shelter assist trucks reversing.

Because trucks enter the dock shelter before the shelter is inflated, there is no friction and therefore no wear on the material. Pressure on the facade with this type of shelter is minimal. When the shelter is not in use, a large clear opening remains available, which makes this type of dock shelter also highly suitable for applications without loading bays, i.e. at road level.



6.2 Curtain shelters

Exceptional versatility and relatively low price make this the most popular type of dock shelter. The curtains (available in different materials) are positioned at a projection of around 600 mm from the facade. As the truck backs up, the curtains clasp the sides and roof, sealing the gap tightly. To assist trucks backing up, the curtains feature high visibility indicators. The projection of a curtain shelter may be achieved by an inbuilt recess or a shelter frame which may be fixed or collapsible. The fixed frame consists of 40 mm sandwich panels and are supported by steel protection bumpers, the shelter forms a permanent unit within the facade construction. The collapsible frame, which is built from either galvanized steel or extruded aluminium profiles, is connected by means of hinged arms.

This construction ensures that the frame will hinge backwards when a misaligned truck fails to enter the dock properly. If the truck does enter correctly, the frame remains at its standard projection at all times. However, we recommend that every effort is made to ensure that trucks always enter the bay correctly. Wheel guides offer a cost effective means of achieving this. (see chapter 10)



6.3. Cushion shelters

On loading bays supporting many trucks of mostly the same height and width, and where climate control is vital, cushion shelters provide the best solution. Cushion shelters ensure an almost airtight seal between the truck and the warehouse.

Because part of the load opening of the truck is backed up against the cushions, this type of shelter is not suitable for companies where palletised loads are being handled, as this increases the risk of damage. During loading and unloading operations,

trucks can 'bounce' up and down. The special armour pleats at the front of the cushions are perfect for dealing with these chafing movements, keeping wear and tear to a minimum. For fleets comprising trucks that are virtually the same in width, but with great variations in height, a combination can be supplied with an inflatable top cushion. The insulating cushion then provides protection at the sides while the inflatable top cushion bridges any differences in height.





6.4. The dimensions of dock shelters

When inviting an offer for dock shelters, the application often refers to the dimensions of the door to be included in the building. However, dock shelters have

little to do with the door. Furthermore, the door opening must be selected to fit the interior mounting dimensions of the shelter.

Key factors in deciding the dock shelter dimensions are:

- A the type of dock shelter
- B presence of bay or not, and its height
- C highest exterior truck dimensions, unloaded
- D lowest exterior truck dimensions, loaded
- E width of trucks, including doors opening outwards



Dock shelters provide protection from moisture, wind, rain and insects to promote a healthier working climate

A The type of dock shelter

1) Curtain shelters

When determining the height and width, you should take into account, amongst other things, that the highest truck must have a clearance of at least 300 mm from the top of the shelter and 200 mm from the sides of the shelter to prevent damage to the frame and/or curtains.

2) Inflatable dock shelters

In the non-inflated condition, the trucks must stay well within the free opening of the shelter. The reach of the inflatable cushions must be selected such that all available truck sizes are sealed.

3) Cushion shelters

In a cushion shelter, the trucks must back up into the cushion with their loading space edges. Cushion shelters are therefore usually smaller than the other types referred to above.

B Presence or absence of a bay, and how high

Dock shelters may be used in situations without a loading bay (road level) and with a loading bay (dock level). For a dock shelter at road level, curtain shelters or inflatable dock shelters are the only option. The height of the shelter is therefore determined from the road level. In the case of a loading bay, the dock shelter is usually mounted with the bottom at dock level. The choice of the shelter dimensions is therefore influenced, in part, by the dock height selected.

C Highest truck

The minimum height of the dock shelter is determined by the highest exterior truck dimensions when unloaded.

D Lowest truck

The length of the dock shelter top cushion/curtain is determined by the lowest exterior truck dimension when loaded.

E Truck width

Particular account has to be taken of the widest trucks with open doors. For example, refrigerator trucks with doors opening outward may have a maximum width of around 2900 mm.

6.5 Example of calculating the dimensions of a curtain shelter

Basic principles:

- Highest truck 4100 mm, unloaded
- Lowest truck 3600 mm, loaded

- Bay height 1200 mm
- Widest truck 2800 mm (with open doors)
- Narrowest truck 2300 mm

The minimum exterior height of the shelter must be:

Highest truck	4100 mm
Plus entry margin	300 mm
Less bay height	1200 mm
Total	3200 mm

A standard height for curtain shelters is 3400 mm.

The minimum exterior width of the shelter is determined as follows:

Widest truck	2800 mm
plus entry margin	400 mm (200 mm on either side)
plus manoeuvring room	300 mm (for truck driver)
Total	3500 mm

A standard width for curtain shelters is 3500 mm. Because a truck must bend back the shelter curtain some 500 mm, the net width between the side curtains must be 2150 mm to provide an adequate seal along the sides of the truck of 2300 mm.



16

15

14

13

12

11

7.0

THE OVERHEAD DOOR

In order to complete a loading bay, an overhead door is usually fitted. These doors, constructed from sections measuring about 600 mm high, are available in steel or aluminium. The counterbalance spring assembly, mounted above the door, makes it very easy to operate by hand. The door may also be provided with an electronic control. This will make its operation even easier, while it also allows for the possibility to connect the operation of the door in series with other dock products. The doors are available in different sizes, colours, and styles. The door must always be smaller than the interior of the dock shelter. The difference in dimensions is also determined by the presence or absence of a bay (is there a bay door or an entry door?). The minimum width of an entry door is 2400 mm while the height lies between 4300 and 4500 mm.

The dimensions of a bay door are determined by:

- the height of the bay
- the type and dimensions of the trucks
- the type of goods
- the type of dock shelters

With curtain shelters and inflatable shelters, the width of the door must equal the internal width of the truck plus 300 mm. This tolerance is needed to unload trucks that are not centred in the door opening. Based on an average fleet, the width of the door can vary between 2800 and 3000 mm.

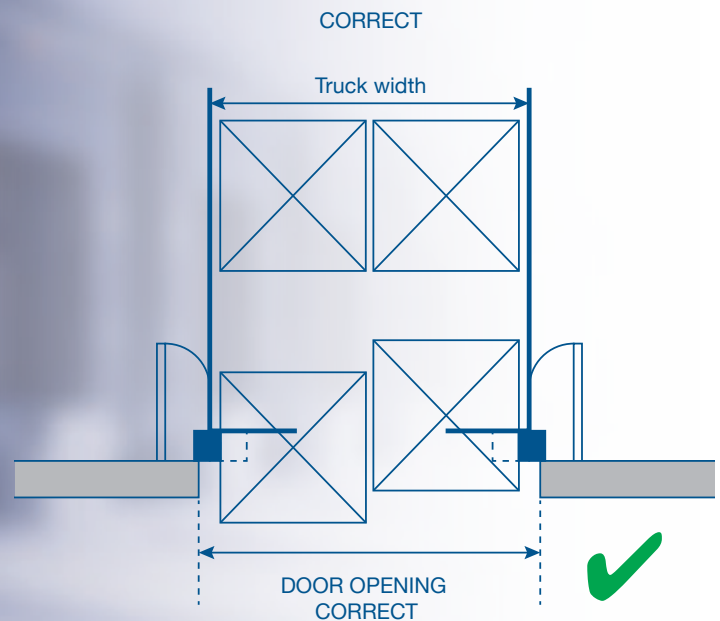
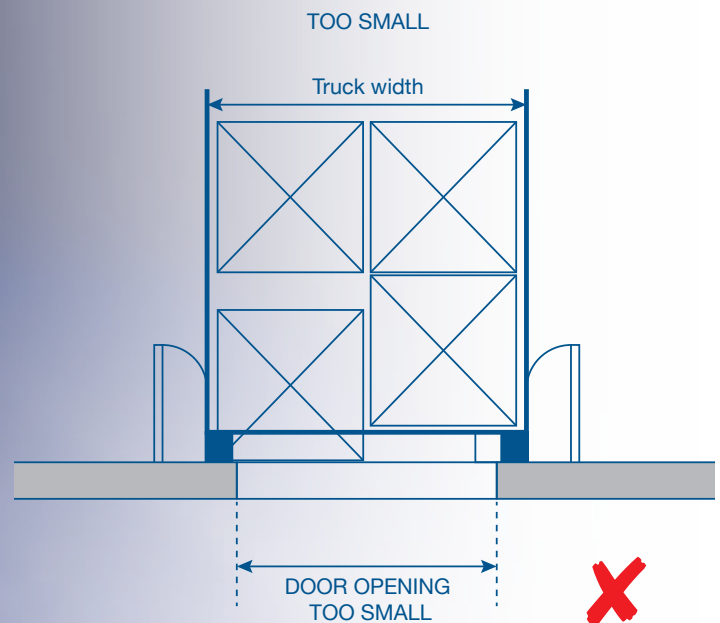



In the case of cushion shelters, the door width equals the interior width of the shelter. The shelter size, in turn, depends on the truck dimensions. The height of the door opening depends on the maximum truck height (3800 to 4200 mm). It is wise to add a safety margin to the maximum height - based on a bay height of 1250 mm, a door with a height of 3000 mm will suffice.

Another point to consider is how the loading bay door should rise when opened. Warehouses are generally tall, enabling the door to rise vertically with little or no travel back into the building. This reduces the risk of damage to the guide tracks by traffic passing through the opening.



In the case of curtain or inflatable shelters, door dimensions of 3000 x 3000 mm is a good choice

8.0

INTERNAL TRANSPORT EQUIPMENT

As described earlier in chapter 5, the length of the dock leveller is also determined by the type of internal transport equipment being used. Such equipment is required to negotiate a slope during loading and unloading operations. The steeper the gradient, the more energy is required to move the goods. The energy needed to operate a hand pallet truck is the pulling power of the employee.





Example:

Pushing a four-wheel cart, loaded with 270kg of goods, requires about 13.5kg pushing power. On a slope of 4%, this increases to 22kg pushing power, and 40.5kg on a slope of 10%, i.e. three times as much. The maximum slope for a hand pallet truck is 3%.

With electric hand pallet trucks, the battery takes over the operation. The maximum slope can then be 5%. The steeper the slope, the more energy the battery must supply, and it will need recharging more frequently. With an electric forklift truck, the slope can be no steeper than 10%. Here, too, the same points apply as with electric pallet trucks. A forklift truck with a fuel engine (petrol/gas) has sufficient power to take a slope of up to 15%; however, the legal maximum is 13%.

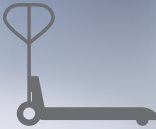
When a truck needs to be loaded above bay level, the platform of the dock leveller is placed at a certain slope relative to the bay. However, the lip of the dock leveller MUST always lie flat on the truck floor. If not, dangerous situations can occur.

Maximum slope percentage for internal transport equipment

	hand pallet truck	3 %
	electric pallet truck	5 %
	electric fork lift truck	10 %
	fork lift truck powered by fuel engine	15 %



Hand pallet truck



Electric pallet truck



Electric fork lift truck



Fork lift truck powered by fuel engine

With the lip lying flat on the truck floor and the platform at a certain slope, the LIP ANGLE is created. A standard lip angle has been selected such that, at a 13% slope, the lip lies flat, or 7.5°. The position of the dock leveller whereby the lip lies flat is the effective range of the dock leveller. This means there is an important difference between the highest position of the dock leveller and its effective range. With pallet trucks, the lip angle may cause problems

(see A). The combination of wheel centres, diameter of wheels and clearance from the underside, determines the maximum lip angle. For a pallet truck, the lip angle cannot be 7.5°, but possibly 3.5° (see figure at bottom of page). When the lip angle is reduced, the slope whereby the lip lies flat will also become smaller. In other words, the leveller's effective range is reduced and a different dock leveller model may be required.

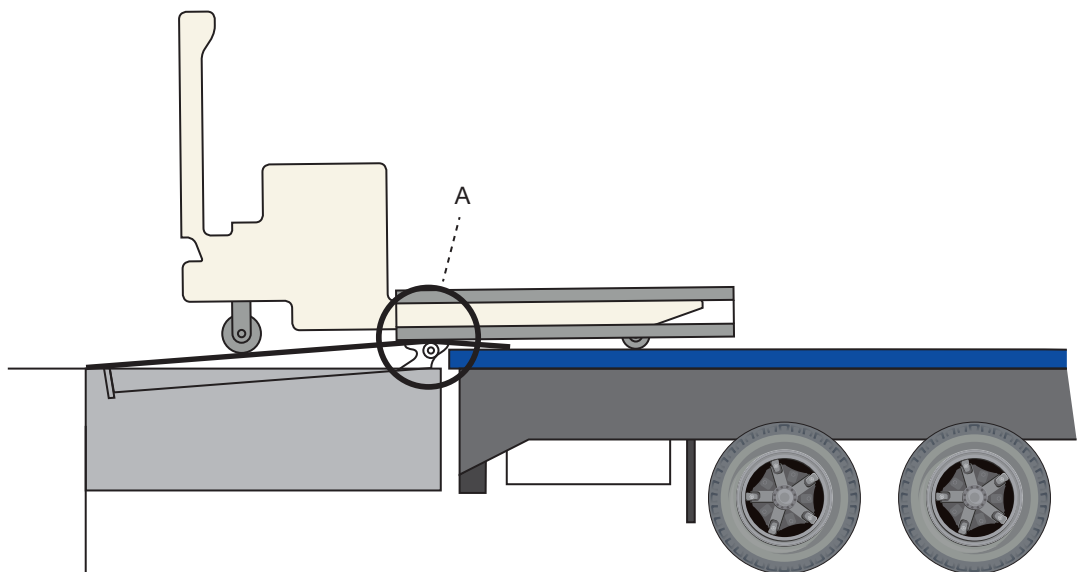

Please be aware, that the different types of internal transport equipment require different slopes which also implicates that the lip angle (see A) must be adapted to the internal transport equipment



9.0

SAFETY STANDARD EN 1398

EN 1398 Directive is the European safety standard for dock levellers set up at the request of the EC member states. The standard lays down a number of points which manufacturers must meet with their design, manufacture and mounting of products. Below we explain a number of these points.

The manufacturer must have the full technical documentation for each dock leveller, including points like stress calculations, cylinder buckling calculations and a description of the safety features applied. Before a manufacturer markets a dock leveller, a prototype must be tested by properly trained staff.

The required load bearing capacity of a dock leveller is determined by the maximum weight (including load) of a forklift truck, measured over one axle of the truck. The load is then measured over two 150 x 150 mm surface areas.

The capacity of the model in question must be established based on a shock factor of 1.5 and a safety factor of 1.33 compared to the yield point of the material.

The control box of the dock levellers (minimum protective class IP 54) must be equipped with an emergency shutdown feature and a lockable main switch. The coils of the electromagnetic valves must be suitable for continuous use.

Various dock products

Naturally, the box must be placed in a location which provides a good view of the dock leveller during its operation.

All hydraulic components, such as cylinders and pipes, must be able to resist at least twice the normal work load without causing damage or lasting deformation.

A user manual, instruction labels and name plate, to be mounted on every dock leveller, will provide the user with information about user regulations, manufacturer, country of origin, capacity and serial numbers.

For a full version of the EN 1398 Directive, please do not hesitate to contact us.





Because of the permanent 380/400 Volt set-up, the INSTALLER guidelines apply to the installation of dock levellers as well as certain shelters. Operation switches are one of the features that result from this guideline. The Veterinary Service has laid down a number of requirements for certain sectors. In spaces where open foodstuffs are being processed, dock shelters have even been made obligatory. In many cases dock levellers must be specially prepared, for example with hot-dip galvanisation.

Last but not least, there is growing safety awareness, partly due to the new Labour Safety regulations, which stress improved security during loading and unloading. The accidental movement and early departure of trucks from a dock can be prevented by truck

restraint systems. (For more information, see chapter 10.) It is obvious that both government and leading institutions have given a lot of thought to guidelines concerning safety. In addition, there is a growing number of companies that have their own specific policies covering such areas as safety, maintenance, fire prevention and the like. It is important to match the operation of products to the regulations that apply to the relevant user, sector or application.

10

ANCILLARY DOCK PRODUCTS

A. Loading pit design

There are many ways to design a dock leveller pit. They all depend on the specific wishes of the builder, customer and type of trailers that are being used.

Pit construction

In order to apply a dock leveller in the bay, a constructional recess will have to be made: the so called pit.

Generally there are two different types of pits:

1. A closed pit in which the leveller will be installed on the concrete pit floor
2. A open pit in which a letterbox (tail lift opening) is integrated

What type of levellers will be integrated in the pit depends on the type of dock leveller selected.

The different options to choose are

1. The standing frame leveller for closed pit design
2. The conventional hanging frame leveller which will be casted in to the concrete, use in open pit design where a letterbox is required
3. When time is important we can offer a leveller which suits the QMS (Quick Mounting System) In case of using the Quick Mounting System, the pit is produced first with QMS curb angles, which makes it possible to place the leveller in QMS execution in the last stage.

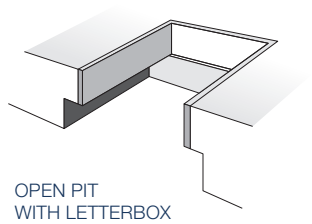
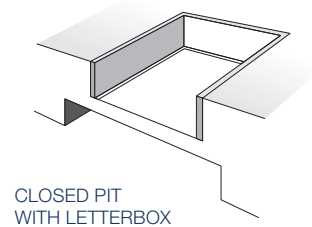
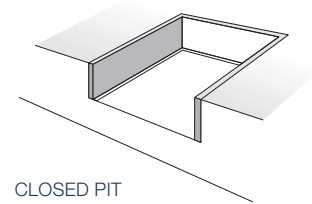

Curb angles

There are several types of curb angles available

1. The straight angle used to cover and protect the horizontal and vertical concrete edges of the pit.
2. The QMS version, the allow you to create the pit and fit the leveller at the end of the building process. The Stertil QMS curb angles protect the pit edges and also assure you the exact dimensions of the pit. Once the pit is completed it eases to fit the leveller and weld it to the curb angles.

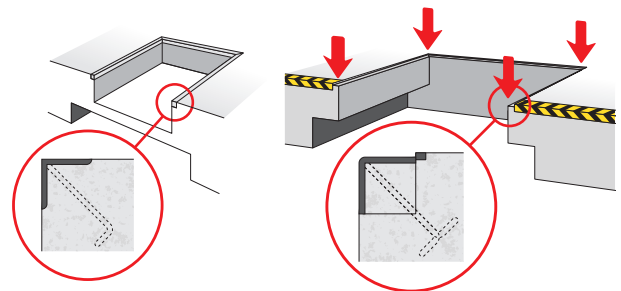

1. STRAIGHT CURB ANGLES

2. QMS CURB ANGLES

Closed box

Another way to integrate a leveller into the pit is with a so called “closed box”. This galvanised “closed box” can be supplied completely assembled, including distance profiles which keep the walls at the exact position during the concrete casting process. Also levellers can be executed in a closed box execution and completely casted in.

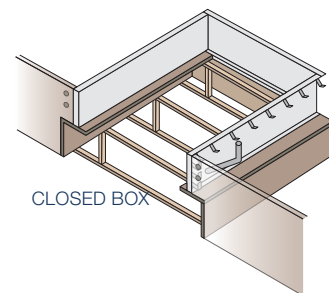

Prefabricated concrete pits

Especially in big projects, it can be interesting to use pre-fabricated concrete pits. These concrete pits are pre-fabricated in a concrete mill. Stertil can supply galvanised curb angles in the correct dimensions, directly to the manufacturer of these prefabricated pits.

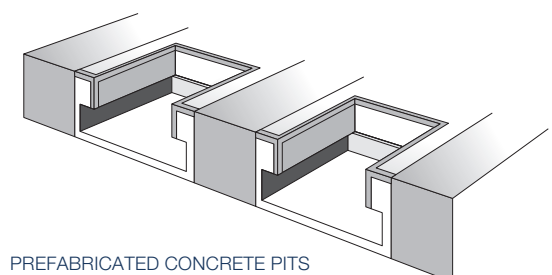

B. Dock bumpers

When a loaded truck backs up into the bay, it can impact heavily on the bay angle. Even docks of reinforced concrete can be damaged quickly. Trucks and loads are also likely to suffer damage. However, by installing dock bumpers, the impact force, and resultant damage, will be reduced tremendously. Stertil offers several dimensions and versions in its product range:

- **R-45-20-5**
rectangular rubber model 450 x 200 x 50 mm
- **R-45-20-10**
rectangular rubber model 450 x 200 x 100 mm
- **R-45-20-15**
rectangular rubber model 450 x 200 x 150 mm
- **L-45-45-10**
L-shape rubber model 450 x 200 x 100 mm
- **B-54-21-17**
moveable rubber model 540 x 210 x 170 mm
- **PE bumper**
polyethylene wearing plate 554 x 220 x 140 mm

Selecting the right bumper depends on many factors but principally on the loading pit and the type of shelter. With its extra large entry area, an L-shaped bumper model offers excellent protection. Dock bumpers are constantly subjected to heavy impact, particularly when trucks 'bounce' during loading or unloading. Also, the back of the truck chafes the front of the bumpers time and again. To reduce the risk of damage and extreme wear, Stertil has developed two solutions - a moveable bumper, which moves when hit by a truck, and a range of PE bumpers. These incorporate a front plate manufactured from Ultra High Molecular Polyethylene, rubber damping strips and a hot galvanised mounting console. Due to low friction properties and the durability of the front plate, the bumpers suffer minimum load forces and damage. The main advantage, however, is that the front plate can be changed quickly and simply without the need to drill new anchors or holes in the concrete.

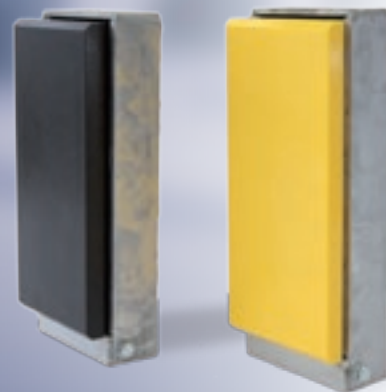

C. Loading Bay Dock Lighting

No more dangerous manoeuvring of heavily loaded forklift trucks in the gloom within a trailer - all goods and obstacles can now be brightly lit by a bay lamp. The hinged arms ensure precise positioning of the lamp to light up every corner. When not in use, the lamp is simply folded towards the wall.



D. LA/HA mini dock leveller

In places where only small differences in height need to be bridged, or where a concrete pit is not possible, a mini-dock leveller can provide the right solution. The STERTIL LA/HA Series mini dock leveller. HA is the hydraulic version mini dock leveller which can be simply mounted against an existing bay. Using an operating bar, the lip of the LA can be manually positioned on the truck floor within a matter of seconds. When the truck moves away, the lip will automatically drop between the mounted bumper consoles, ready for the next truck.





E. Wheel guides.

Wheel guides, mounted on the approach to the loading bay, increase safety during loading and unloading and increase the life of dock shelters considerably. Trucks are forced to enter centrally and the rounded shapes of the steel wheel guides are safe to tyres, unlike the relatively sharp edges of concrete ramps. The recommended interior distance between the left and right wheel guide is 2600 mm.

Wheel guides are easy to mount on concrete, concrete driving plates or in bases poured into the access route.



F. Vehicle Truck Restraint System COMBILOK®

To manage business operations in a responsible manner, a reliable vehicle restraint system is a necessity within all loading bays. The risk of damage caused by accidents during loading and unloading activities increases significantly as a result of tight time constraints. The communication between warehouse staff and drivers (in their cabs) often leaves a lot to be desired.

Prematurely driving away from the dock while the lorry is still being loaded or unloaded is not uncommon. The same applies when considering the risk of a docked lorry creeping forwards. The unique COMBILOK from Stertil limits all of these risks and offers many unique safety benefits.



Read more in our
COMBILOK brochure

G. Dock house

A dock house is a construction combining a dock leveller and a dock shelter. It offers a good solution for situations where pit recesses cannot be built, for example in existing concrete bays. Cutting out floors is often an expensive and awkward job. When a dock house can be placed against the existing facade, it can be simply moved after a few years if required. In refrigeration and freezer applications, locating a dock house may involve specific considerations. In order to maintain the extra insulated construction, it is often better to place the entire loading and unloading unit outside the facade.

The dock house can be built with a substructure in steel or concrete framework. The top structure, comprising of hot-dip galvanised profiles, can be clad with uninsulated sheeting or insulated panels. The size of the dock house will depend on the shelter and dock leveller model selected.



Designed to make it

EASY FOR ARCHITECTS



There is a support section "Architects Library" on our website available. You find there BIM (Rivet) files specially designed and created for architects and building engineers, also including our product brochures.

Scan the QR code to go there!



Further information

For further or specific information about our products, levellers, shelters, dock houses, vehicle restraint systems, etc., please get in contact with us.

We will be happy to assist you with personal advice to ensure that you receive a superior solution.



A member of the Steril Group



Stertil B.V.
P.O.Box 23
9288 ZG Kootstertille
The Netherlands
Tel. +31 (0)512 334444
www.stertil.com
info@stertil.nl
f Stertil Dock Products
@Stertil

 A member of the Stertil Group

95004110 How-to-Design-GB 09-2015. Stertil is a registered trademark of Stertil B.V.. We reserve the right to make changes in specifications without notice and without making changes retroactive.